

Name: \_\_\_\_\_

**Instructions:** Count and colour the **20** hammers.

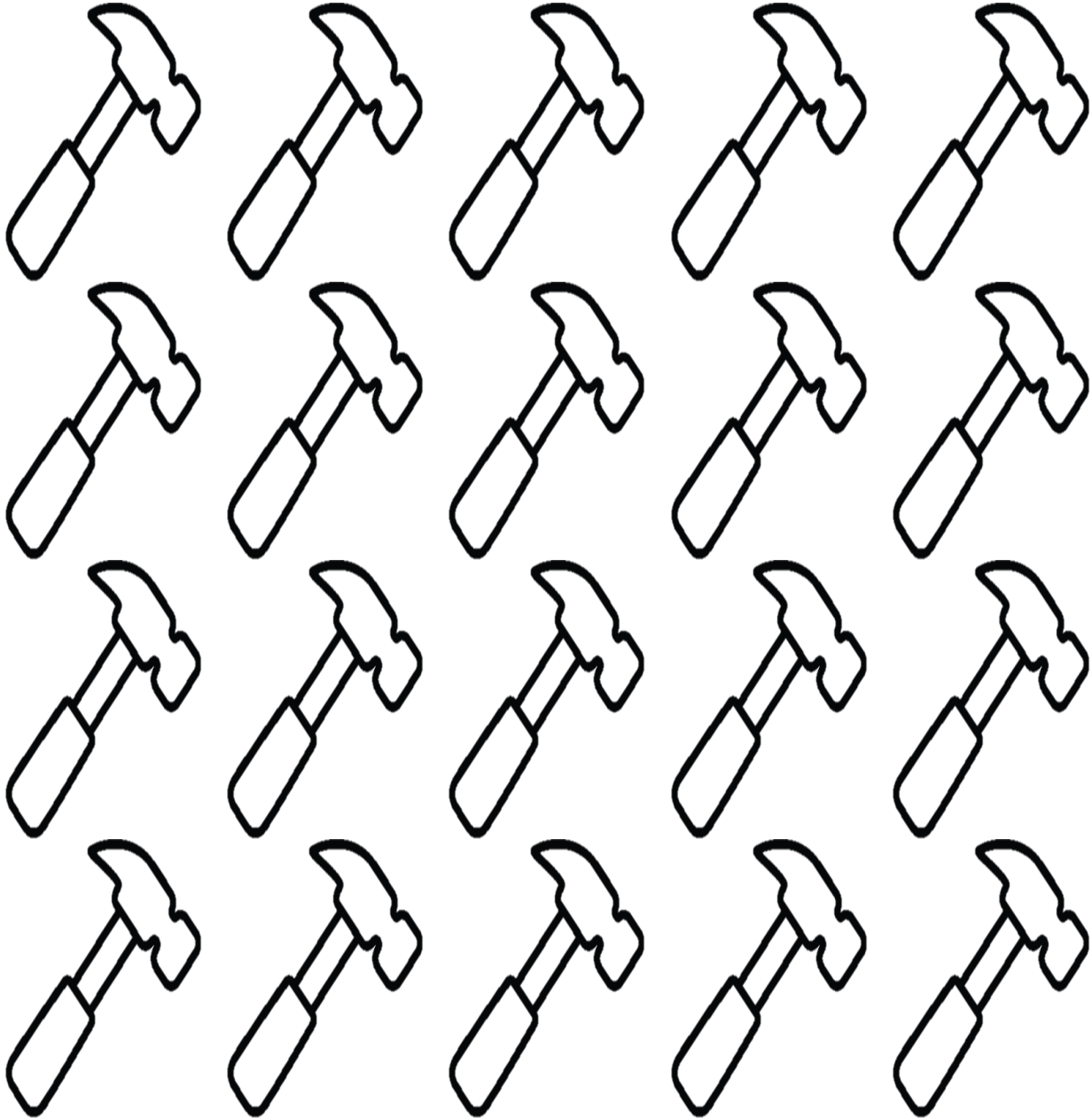

<b>20</b>	<b>twenty</b>
-----------	---------------

Name: \_\_\_\_\_

**Instructions:** Circle all the numeral **20**'s. Trace then write the numeral and number name **twenty**.

20

20	18	15	16	12
11	20	14	20	15
13	10	20	14	20
10	20	12	19	17
13	16	17	11	20

20 twenty

20 twenty

20 twenty

\_\_\_\_\_

\_\_\_\_\_

Name: \_\_\_\_\_

**Instructions:** Match the sets that have the same amount.

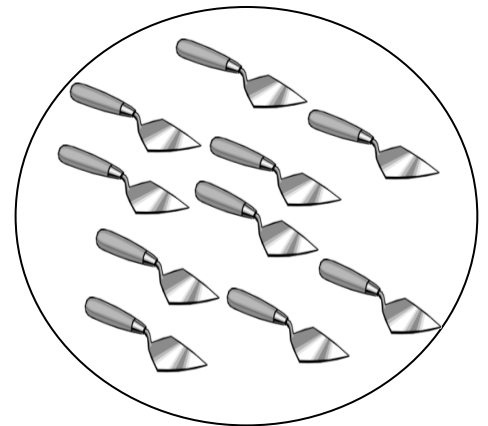
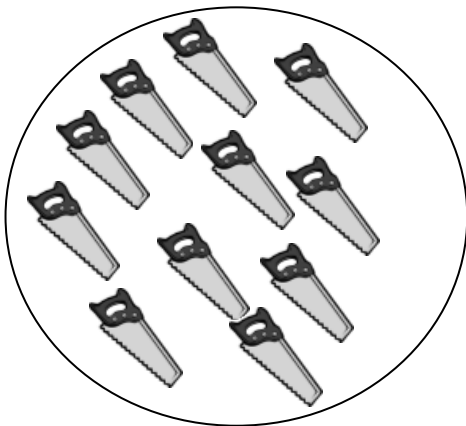
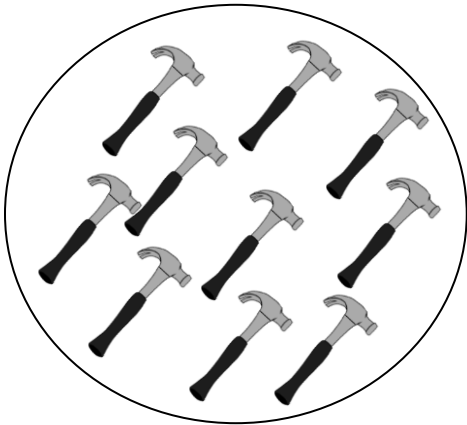
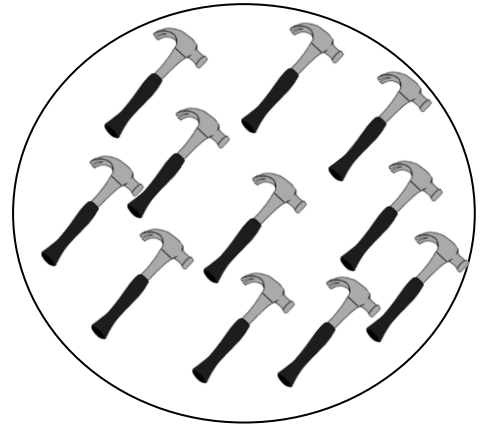
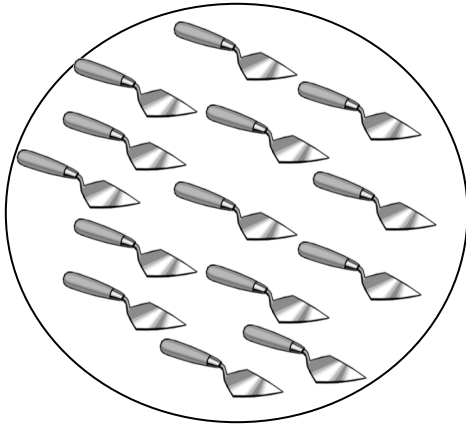

Name: \_\_\_\_\_

**Instructions:** Count then put an X on the numeral to show how many.

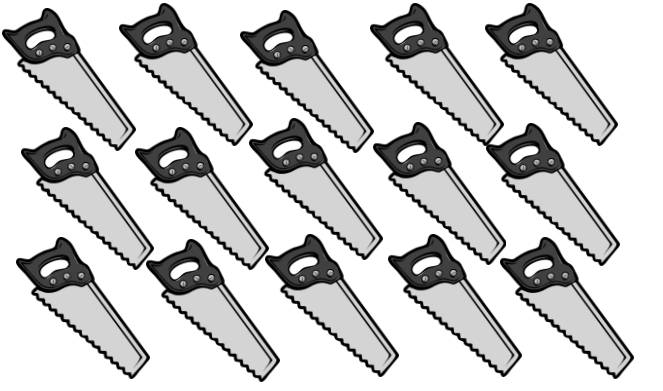

**14      15      16**



**18      19      20**

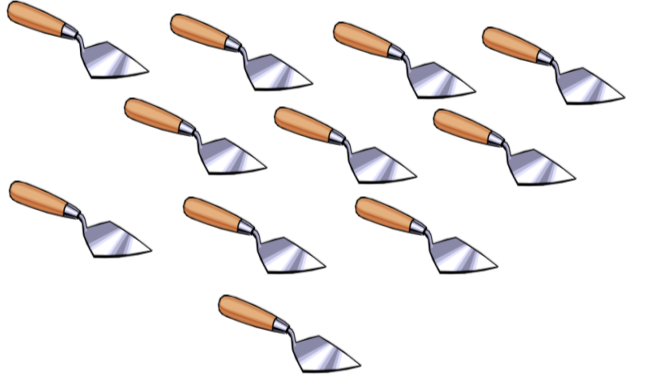

**13      11      14**





**17      16      14**

Name: \_\_\_\_\_

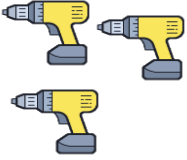
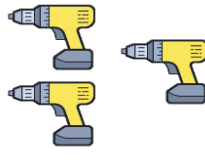

**Instructions:** Count then solve the problems. Circle the correct answer to complete the number sentence. The first one was done for you.

 +  = 6  
5

3                      3

 +  = 5  
4

3                      1

 +  = 6  
5

3                      2

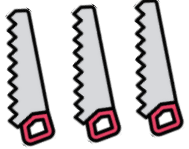
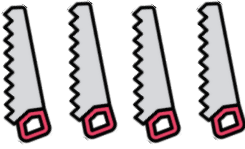
 +  = 7  
5

3                      4